



PALAVRAS CHAVES/KEY WORDS
AUTORES / **AUTHORS**
 TELEMETRY ENCODER - ON BOARD SUPERVISION
 DATA ACQUISITION SYSTEM - TELEMETRY FORMATS

AUTORIZADA POR/AUTHORIZED BY
Marco Antonio Raupp
 Director General

AUTOR RESPONSÁVEL
 RESPONSIBLE AUTHOR
Alderico R. Paula Junior
 Alderico R. Paula Junior

DISTRIBUIÇÃO/DISTRIBUTION
 INTERNA / INTERNAL
 EXTERNA / EXTERNAL
 RESTRITA / RESTRICTED

REVISADA POR / REVISED BY
Klaus Juergen Johansen
 Klaus Juergen Johansen

CDU/UDC
 621.398:629.783

DATA / DATE
 October 1987

TÍTULO/TITLE	PUBLICAÇÃO Nº PUBLICATION NO INPE-4410-RTR/109
	DIRECT TELEMETRY ENCODER SPECIFICATION
AUTORES/AUTHORSHIP	Alderico Rodrigues de Paula Junior Ricardo de Azevedo Mendes

ORIGEM
 ORIGIN
 DCA

PROJETO
 PROJECT
 SUBORD

Nº DE PAG.
 NO OF PAGES
 23

ULTIMA PAG.
 LAST PAGE
 14

VERSÃO
 VERSION
 1

Nº DE MAPAS
 NO OF MAPS

RESUMO - NOTAS / ABSTRACT - NOTES

This document presents the performance requirements for the Direct Telemetry Encoder (CODIR). This equipment is part of The On Board Supervision Subsystem to be used in the MECB/SI satellites. The CODIR shall acquire bi-level, thermistor and analog telemetry signal from the satellite subsystems, convert the analog signals to digital ones format the acquired data in telemetry frames and transmit them to the ground segment. The CODIR architecture and module functions are defined.

OBSERVAÇÕES / REMARKS

RESUMO

Este documento apresenta os requisitos de desempenho do Codificador Direto de Telemetria (CODIR). Este equipamento faz parte do Subsistema de Supervisão a ser utilizado nos satélites da MECB/SI. O CODIR deverá adquirir os sinais de telemetria digital, analógica e dos termistores, converter os sinais analógicos em digitais, formatar os dados adquiridos em quadros de telemetria e transmiti-los para o segmento solo. A arquitetura e as funções dos módulos do CODIR são definidos.

LIST OF CONTENTS

	<u>Page</u>
LIST OF FIGURES.....	<i>v</i>
LIST OF TABLES.....	<i>vii</i>
1 - <u>PURPOSE</u>	1
2 - <u>APPLICABLE AND REFERENCE DOCUMENTS</u>	1
2.1 - Applicable documents (AD).....	1
2.2. - Reference documents.....	1
3 - <u>TECHNICAL REQUIREMENTS</u>	2
3.1 - Equipment definition.....	2
3.1.1 - Equipment description.....	2
3.1.1.1 - Controller.....	3
3.1.1.2 - Bi-level, analog and thermistor interfaces.....	3
3.2 - Interface definition.....	4
3.3 - Performance requirements.....	4
3.3.1 - Analog channels.....	4
3.3.2 - Thermistor channels.....	5
3.3.3 - Bi-level channels.....	5
3.3.4 - Telemetry frame.....	7
3.3.5 - TM Video.....	7
3.3.6 - On-board computer interface requirements.....	8
3.4 - Design and construction requirements.....	9
3.4.1 - Lifetime.....	9
3.4.2 - Reliability.....	9
3.4.3 - Redundancy.....	10
3.4.4 - Interchangeability.....	10
3.4.5 - Maintainability.....	10
3.4.6 - Electrical requirements.....	10
3.4.7 - Grounding requirements.....	12
3.4.8 - EMC requirements.....	12
3.4.9 - Environmental requirements.....	13
3.4.10 - Mechanical requirements.....	13
3.4.11 - Thermal requirements.....	13
3.4.12 - Test points.....	13

	<u>Page</u>
3.4.13 - Safety.....	13
3.4.14 - Workmanship.....	13
3.4.15 - Identification of product.....	14
3.4.16 - Product assurance.....	14
3.4.17 - Material, components and process.....	14
3.4.18 - Preparation for delivery.....	14

LIST OF FIGURES

	<u>Page</u>
1 - CODIR block diagram.....	2
2 - Telemetry frame.....	7
3 - OBC interface.....	8
4 - CODIR power supply interfaces.....	11

LIST OF TABLES

	<u>Page</u>
1 - CODIR maximum power consumption.....	11
2 - CODIR EMC requirements.....	12



MECB/SS

1. PURPOSE

This document establishes the requirements for performance, design, fabrication and test of the Direct Telemetry Encoder (CODIR) to be used in the MECB/S1 satellite.

2. APPLICABLE AND REFERENCE DOCUMENTS

2.1 - APPLICABLE DOCUMENTS (AD)

- a) spacecraft specification A-ETC-0002 ;
- b) spacecraft to ground interface specification A-EIF-0002 ;
- c) design and construction specification A-ERC-0001;
- d) environmental specification A-EAB-0001 ;
- e) EMC specification A-ECE-0001 ;
- f) spacecraft product assurance plan A-GQL-0006 ;
- g) listas preferenciais de componentes A-GQL-0008 ;
- h) listas preferenciais de materiais e processos A-GQL-0009 ;
- i) PSS-45 ESA PCM telecommand standard (April 78) ;
- j) PSS-46 ESA PCM telemetry standard (April 78) ;
- l) on-board supervision subsystem A-ETC-0007.

2.2 - REFERENCE DOCUMENTS

- a) plano de desenvolvimento e teste do satélite de coleta de dados A-GRC-0010 ;
- b) on board supervision system preliminary design review A-Rev-0007 ;
- c) the direct telemetry encoder: a detailed description A-Rev-0011.

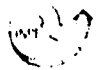

MECB/SS

3 - TECHNICAL REQUIREMENTS

3.1 - EQUIPMENT DEFINITION

The Direct Telemetry Encoder (CODIR) shall acquire bi-level, analog and thermistor telemetry signals from the satellite subsystems. The CODIR shall sample the telemetry channels cyclically at a defined rate and convert the analog signals to digital ones. In addition, the CODIR shall format the acquired telemetry data in frames adding a header to the beginning of the frame and an error control word to the end. The frames shall be continuously generated producing a bit stream. The bit stream shall be bi-phase encoded and PSK modulated producing the telemetry video that shall be sent to the transponder, umbilical and integration connectors. The CODIR shall also house an independent circuit that operates under on board computer control to multiplex the bi-level, analog and thermistor telemetry signals. In addition, the CODIR shall house a circuit that supply bias to the thermistors.

3.1.1 EQUIPMENT DESCRIPTION

The CODIR shall be composed by a controller, a bi-level telemetry interface, an analog telemetry interface and a thermistor telemetry interface as depicted in Figure 1.

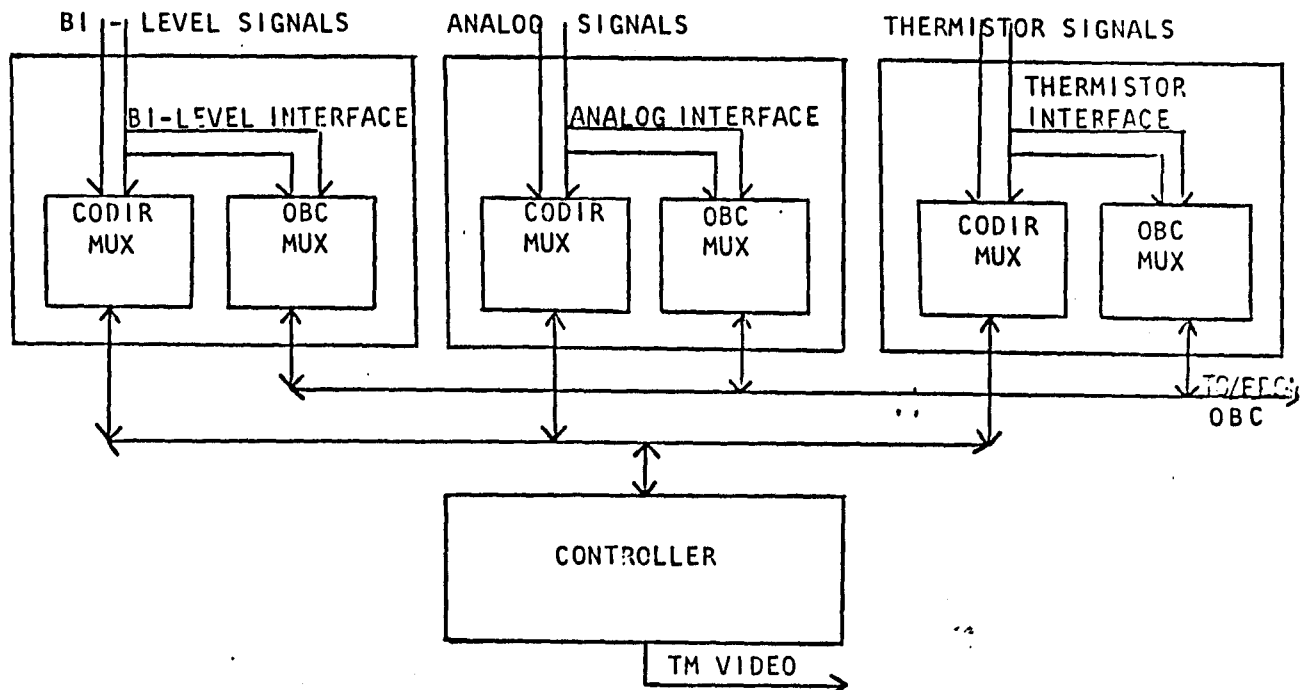

Fig. 1 - CODIR block diagram.



MECB/SS

3.1.1.1 - CONTROLLER

The controller shall provide the addresses for the bi-level analog and thermistor multiplexers, convert the analog telemetry signals to digital ones and format the acquired telemetry in frames. In addition, the controller shall transmit the frames continuously producing a bit stream that shall be bi-phase encoded and PSK modulated.

3.1.1.2 - BI-LEVEL, ANALOG AND THERMISTOR INTERFACES

Each interface shall consist of two sets of differential multiplexers that shall be energized independently of the controller. The first set shall be addressed by the CODIR controller, while the second one shall be addressed by the on-board computer.

The two sets of multiplexers shall be isolated one from the other by resistors to protect them against over-voltage and to avoid that failures in one set of multiplexers affect the other set.



MECB/SS

3.2 - INTERFACE DEFINITION

The CODIR interfaces shall be:

- a) analog, thermistor and bi-level telemetry channels with the satellite subsystems;
- b) telemetry video output with two S-band transponders, one umbilical connector and one integration connector;
- c) address lines and reference line with the on-board computer;
- d) two sets of differential lines with the on-board computer for transmission of multiplexed telemetry data;
- e) power supply;
- f) technical and thermal interface with the satellite.

3.3 - PERFORMANCE REQUIREMENTS

3.3.1 - ANALOG CHANNELS

Each analog channel shall be acquired by the CODIR at a rate of 2 samples per second and, then, shall be converted to digital one. The analog acquisition interface shall satisfy the following requirements:

- a) Capacity: 64 differential channels.
- b) A/D converter: 8 bits.
- c) A/D converter function: $Z = \frac{U - 10\text{mV}}{20\text{mV}}$ (rounded to the next integer), where U is the input voltage in mV and the range of Z is from zero to 255.
- d) Acquisition accuracy $\pm 1\%$ of the full scale.
- e) Acquisition time diagram of a channel:

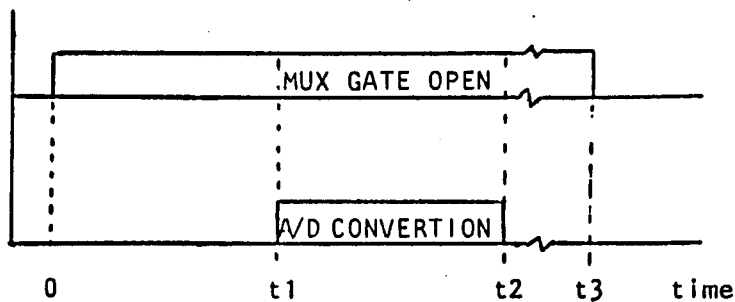

where:

T1: $122 \pm 1 \mu\text{sec}$;

T2 - T1: $25 \pm 5 \mu\text{sec}$;

T3: $3906 \pm 1 \mu\text{sec}$;

e) Electrical interface: described in AD 2.1.c.

3.3.2 THERMISTOR CHANNELS

Each thermistor channel shall be sampled by the CODIR at a rate of 2 samples per second and, then, converted to digital one. The Thermistor acquisition interface shall satisfy the following requirements:

- a) Capacity: 32 channels.
- b) A/D converter: 8 bits.
- c) A/D converter function:

$$Z = \frac{U - 10 \text{ mV}}{20 \text{ mV}} \text{ (rounded to the next integer),}$$

where U is the input voltage in mV and the range of Z is from 0 to 255.

d) Acquisition time diagram of a channel:

Same as the analog channels.



MECB/SS

e) Thermistor voltage bias, V_b : $5V \pm 1\%$

f) Thermistor circuit:

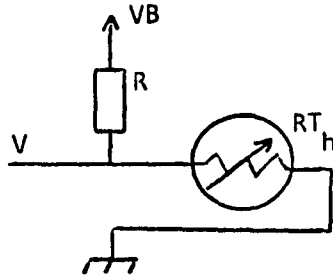

where $R = 20 \text{ K} \Omega \pm 1\%$

g) Electrical interface : similar to the analog channels.

3.3.3 - BI-LEVEL CHANNELS

Each bi-level channel shall be sampled by the CODIR at a rate of 2 samples per second. The bi-level acquisition interface shall satisfy the following requirements:

- a) Capacity: 64 differential channels.
- b) Threshold voltage: 1.66 ± 0.2 .
- c) Acquisition time diagram:

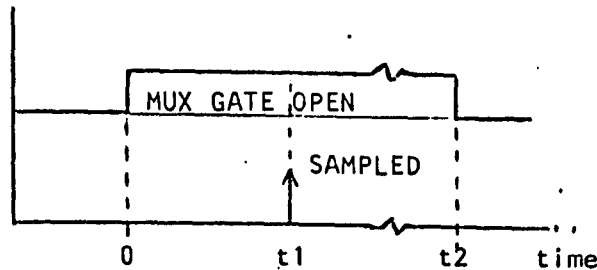

where

$$T1 = 244 \pm 1 \mu\text{sec},$$

$$T2 = 488 \pm 1 \mu\text{sec}.$$



MECB/SS

d) Electrical interface is described in AD 2.1 C.

3.3.4 - TELEMETRY FRAME

The acquired telemetry data shall be formatted in 128 octed frames as depicted in Figure 2.

0-1	2	3	4-11	12-15	16-47	48-111	112-125	126-127
SYNC	FRAME NUMBER AND MODE	FORMAT NUMBER	DIGITAL TELEMETRY DATA	SPARE	THERMISTOR TELEMETRY DATA	ANALOG TELEMETRY DATA	SPARE	CRC

where:

Sync word: 1110 1011 1001 0000 (Binary).

Frame number: 0000 (BINARY).

Mode: 1100 (BINARY).

Format number: from 0000 0000 to 1111 1111 (BINARY).

CRC polynomial: $x^{16} + x^{12} + x^5 + 1$ (generated from octed 2 to 125).

Fig. 2 - Telemetry frame.

3.3.5 - TM VIDEO

The telemetry frame shall continuously be generated at the rate of two frames per second producing a NRZ bit stream. Then, the bit stream shall be bi-phase encoded and modulate a square wave subcarrier in PSK producing the telemetry video. The TM video shall satisfy the following requirements:



MECB/SS

- PSK carrier frequency: $65,536 \pm 10$ Hz square wave.
- Data stream bit rate: 2048 bps derived from the same oscillator as the PSK carrier.
- Data stream code: bi-phase L.
- Out put channels: 4.
- Electrical interface: described in AD 2.1.1.

3.3.6 - ON-BOARD COMPUTER INTERFACE REQUIREMENTS

The multiplexer sets under control of the on-board computer (OBC) shall be addressed by seven lines and a reference line. The reference line shall indicate the level to compare the address lines and to inhibit the output multiplexers when the OBC is off. The outputs of the multiplexers utilized to acquire analog and thermistor telemetry signals and bi-level telemetry signals shall be connected to the OBC through two sets of differential lines, as described in Figure 3.

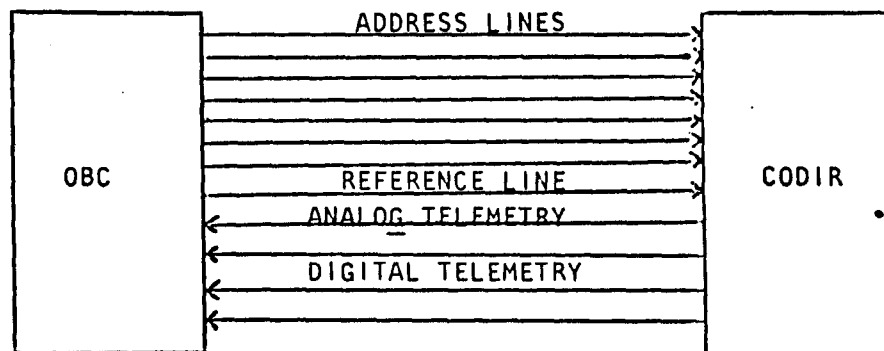

Fig. 3-OBC interface.

Electrical Interfaces:

- a) Address and reference line:
 - input impedance: $100K\Omega$ minimum ;
 - input capacitance: 100 pf maximum ;



MECB/SS

over voltage capability: $\pm 16V$ maximum.

b) Analog and digital differential line.

b.1) Output impedance:

during acquisition: $50K\Omega$ maximum + the output impedance of the telemetry line of the selected channel;

outside acquisition: $1M\Omega$ maximum.

b.2) Voltage range:

during acquisition: same as the select channel limited in $-5,5$ to $5,5V$;

outside acquisition: tri-state ;

over voltage capability: $\pm 16V$ (with an over voltage source impedance of $2K\Omega \pm 5\%$).

3.4 - DESIGN AND CONSTRUCTION REQUIREMENTS

The subsystem equipments shall meet the following design and construction requirements, except where specifically excluded.

3.4.1 - LIFETIME

The subsystem shall be designed to meet all specifications for a life expectancy of up to 1 year of integration and tests, 2 years storage and 6 months mission over all environmental conditions specified in Section 3.3.5.

3.4.2 - RELIABILITY

The CODIR shall meet the requirements of these specifications for the mission lifetime defined in Section 3.3.3.1, with the minimum reliability of 0.98 for a 6 month mission.



MECB/SS

3.4.3 - REDUNDANCY

The telemetry signal shall be acquired by two independent sets of multiplexers, one controlled by the CODIR and the other controlled by the on-board computer. A resistor of $47k\Omega \pm 5\%$ shall be inserted into the input of each multiplexer channel to protect the multiplexers against over voltage and to isolate the multiplexers addressed by the CODIR controlled from the multiplexers addressed by the on-board computer.

3.4.4 - INTERCHANGEABILITY

The interchangeability requirements shall be in accordance with Section 3.5 of AD 2.1.c.

3.4.5 - MAINTAINABILITY

The subsystem equipments shall be designed such that replacement and maintainability can be readily carried out as the manufacture premises, in accordance with AD 2.1.c.

3.4.6 - ELECTRICAL REQUIREMENTS

The controller, the multiplexers addressed by the controller, the multiplexers addressed by the OBC and the thermistor circuits shall be connected to the power supply using independent lines, as described in Figure 4.



MECB/SS

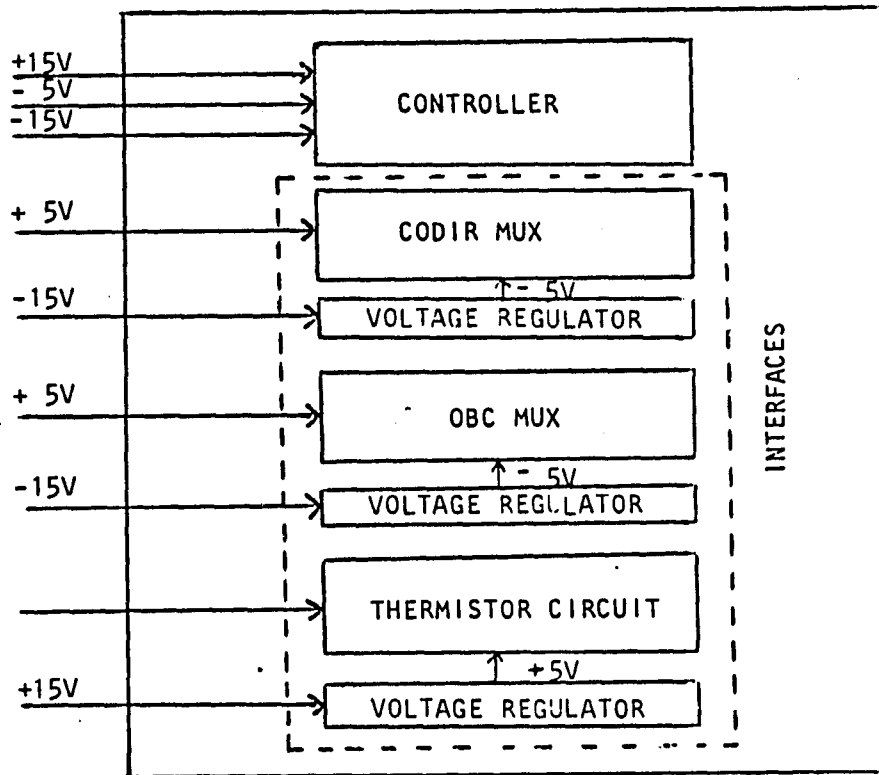

Fig. 4 - CODIR power supply interfaces.

The CODIR maximum power consumption is presented in table 1.

TABLE 1
CODIR MAXIMUM POWER CONSUMPTION.

MODULES	VOLTAGE		
	15V \pm 5%	5V \pm 5%	-15V \pm 5%
CONTROLLER	0,45W	0,43W	0,66W
CONTROLLER MUX	-	0,030W	0,045W
OBC MUX	-	0,045W	0,045W
THERMISTOR CIRCUIT	0,18W		



MECB/SS

3.4.7 - GROUNDING REQUIREMENTS

The groundig requirements are defined in the Design and Construction Specification (AD 2.1.c)

3.4.8 - EMC REQUIREMENTS

The CODIR shall be designed in accordance with the requirements of AD 2.1.c. The test classes are defined in table 2.

TABLE 2

CODIR EMC REQUIREMENTS

TEST		CLASS1	CLASS2	CLASS3
CONDUCTED EMISSION POWER LINE	± 15V		X	
	5V			X
CONDUCTED EMISSION POWER LINE COMMON MODE	± 15V		X	
	5V			X
RADIATED EMISSION E-FIELD		X		
RADIATED EMISSION H - FIELD		X		
CONDUCTED SUSCEPTIBILITY COMMON MODE	± 15V		X	
	5V			X
RADIATED SUSCEPTIBILITY E - FIELD		X		
RADIATED SUSCEPTIBILITY H - FIELD		X		



MECB/SS

3.4.9 - ENVIRONMENTAL REQUIREMENTS

The subsystem shall be designed to withstand all mechanical, thermal, climatic and other in-orbit (pressure and radiation) environmental conditions defined in AD 2.1.d.

3.4.10 - MECHANICAL REQUIREMENTS

The mechanical requirements shall be in accordance with AD 2.1.c.

The CODIR shall be assembled in one box with the maximum dimensions of 250 x 230 x 150 mm (not including the attachment lugs), and the total mass shall be less than 5 Kg.

3.4.11 - THERMAL REQUIREMENTS

The thermal requirements shall be according to AD 2.1.c. The temperature limits shall be:

- Operation range: - 10 to 50^oC.
- Startup: 20^oC.
- Qualification range: - 20 to 60^oC.

3.4.12 - TEST POINTS

Test points shall comply with the specifications of AD 2.1.c

3.4.13 - SAFETY

The CODIR shall meet the safety requirements specified in AD 2.1.c.

3.4.14 - WORKMANSHIP

The CODIR shall be built to standards normally associated with satellite hardware and shall be in accordance with AD 2.1.c.



MECB/SS

3.4.15 -IDENTIFICATION OF PRODUCT

The CODIR shall be identified in accordance with AD 2.1.c.

3.4.16 -PRODUCT ASSURANCE

The CODIR shall be designed and constructed according to the requirements of AD 2.1.f.

3.4.17 -MATERIAL, COMPONENTS AND PROCESS

Components, materials and processes used must comply with AD 2.1.c.

3.4.18 -PREPARATION FOR DELIVERY

Each subsystem equipment and part shall be shipped in accordance with AD 2.1.c.



PROPOSTA PARA PUBLICAÇÃO

DATA
08.09.87

IDENTIFICAÇÃO	TÍTULO	
	DIRECT TELEMETRY ENCODER SPECIFICATION	
	AUTORIA	
	Ricardo de Azevedo Mendes Alderico R. de Paula Junior	
		PROJETO/PROGRAMA
		SUBORD
		DIVISÃO
		DEPARTAMENTO
		DCA
DIVULGAÇÃO <input type="checkbox"/> EXTERNA <input checked="" type="checkbox"/> INTERNA MEIO: RTR		

REVISÃO TÉCNICA	REVISOR TÉCNICO		APROVADO: <input type="checkbox"/> SIM <input type="checkbox"/> NÃO <input type="checkbox"/> VER VERSO	
	<i>Manoel N. Johanna</i>		DATA _____ CHEFE DIVISÃO _____	
	RECEBI EM: _____	REVISADO EM: _____	APROVADO: <input checked="" type="checkbox"/> SIM <input type="checkbox"/> NÃO <input type="checkbox"/> VER VERSO	
	OBSERVAÇÕES: <input type="checkbox"/> NÃO HÁ <input type="checkbox"/> VER VERSO		13.10.87 <i>Eduardo Whitaker Bergamini</i>	
DEVOLVI EM: _____		DATA _____ CHEFE DEPARTAMENTO _____		
		<i>Manoel N. Johanna</i> ASSINATURA		

REVISÃO DE LINGUAGEM	Nº: <u>227</u>		PRIORIDADE: <u>2</u>		O(S) AUTOR(ES) DEVE(M) MENCIONAR NO VERSO, OU ANEXAR NORMAS E/OU INSTRUÇÕES ESPECIAIS	
	DATA: <u>11-9-87</u>					
	REVISADO <input type="checkbox"/> COM <input type="checkbox"/> SEM		CORREÇÕES <input type="checkbox"/> VER VERSO		RECEBIDO EM: _____ CONCLUÍDO EM: _____ DATILÓGRAFA: <u>Ana Maria/R.317</u>	
	POR: <u>Paulina Prado de Carvalho</u>		<u>Paulina P. Carvalho</u>			
		DATA: <u>15.9.87</u>		<u>Ana Maria</u> ASSINATURA		

PARECER			
FAVORÁVEL: <input type="checkbox"/> SIM <input type="checkbox"/> NÃO	<input type="checkbox"/> VER <input type="checkbox"/> VERSO	DATA _____	RESPONSÁVEL/PROGRAMA _____

EM CONDIÇÕES DE PUBLICAÇÃO EM: _____	<i>[Signature]</i> AUTOR RESPONSÁVEL
--------------------------------------	---

AUTORIZO A PUBLICAÇÃO: <input type="checkbox"/> SIM <input type="checkbox"/> NÃO	
DIVULGAÇÃO <input type="checkbox"/> INTERNA <input type="checkbox"/> EXTERNA	MEIO: _____
OBSERVAÇÕES: _____	
DATA _____	DIRETOR _____

SEC	PUBLICAÇÃO: _____ PÁGINAS: _____ ÚLTIMA PÁGINA: _____
	CÓPIAS: _____ TIPO: _____ PREÇO: _____